

Introduzione alla Realtà Virtuale Parte I

Prof. Alberto Borghese
alberto.borghese@unimi.it



1/80

<http://borghese.di.unimi.it/>



Sommario



- **Introduzione**
- Sistemi di Input
- Generatori di mondi
- Motore di calcolo
- Sistemi di Output
- Conclusioni

A.A. 2016-2017

2/80

<http://borghese.di.unimi.it/>



Which is real, which is virtual?



A.A. 2016-2017

3/80

<http://borghese.di.unimi.it/>



Historical Perspective (I)



- The name “Virtual Reality” has been attributed to Jaron Lanier (VPL), 1986.
- *Virtual Worlds or Synthetic Environments*
- *Philosophical and Technological* origin.

Philosophical background

Ontology and Gnoseology.

- Plato (world of the ideas) 428-348 a.C.
- Berkeley (sensorial experience is too limited) 1685-1753.
- Hegel (“what is rational is real..”) 1770-1831.
- New age.

A.A. 2016-2017

4/80

<http://borghese.di.unimi.it/>



Historical Perspective (II)

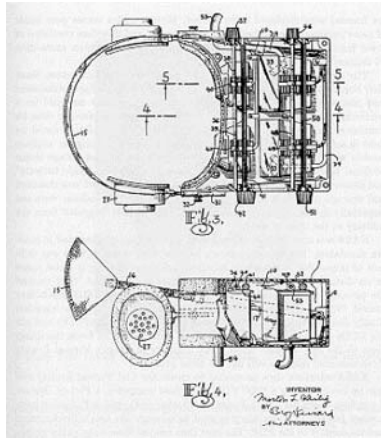

Morton Heilig 1956,
patented in 1961
Non fu mai costruito

projected film,
audio, vibration,
wind, odors.

A.A. 2016-2017

5/80

<http://borghese.di.unimi.it/>



Historical Perspective (III)



Technological background

- *Philco HMD, 1961.*
- *“Ultimate display”, Sutherland, 1970.*
- *Data Glove, VPL Research, 1988.*

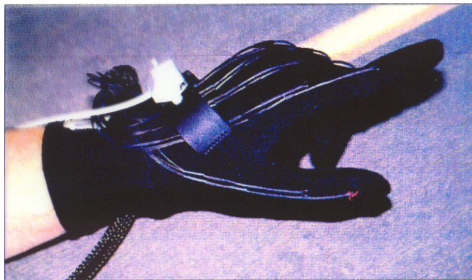

Sutherland, Ivan E. 1968. "A Head-Mounted Three Dimensional Display," pp. 757-764 in Proceedings of the Fall Joint Computer Conference. AFIPS Press, Montvale, N.J.

A.A. 2016-2017

6/80

<http://borghese.di.unimi.it/>



Virtual Reality Systems



Key characteristics are:

Immersivity.

Interactivity.

VR should be able to stimulate the human sensorial systems

In a coordinated way.

VR output should be able to saturate our sensor systems, congruently.



A typical VR system



VR systems are constituted of:

- *Input systems* (measure the position *in* the environment and force *over* the environment).
- *World generators* (provides a realistic virtual world in which to act).
- *Computational engine* (computes the output, given the input and the virtual world).
- *Output systems* (outputs sensorial stimuli *on* the subject. Vision, sound, force ... are generated as if they were provided *by* the virtual environment).



Sommario



- Introduzione
- **Sistemi di Input (trackers)**
- Generatori di mondi
- Motore di calcolo
- Sistemi di Output
- Conclusioni



Input systems



Measure human actions on the virtual environment.

- **Position.** Measure the position of the body segments inside the virtual environment.
- **Force.** Measure the force exerted by the body segments when in contact with a virtual object.
- Estimate the motor output of the human muscle-skeleton system.



Tracking systems



- Measure the position of the body segments inside the virtual environment.
- **Motion capture** (batch, complete information on the movement).
- **Real-time trackers** (real-time position of the body).
- **Gloves** (specialized for hands).
- **Gaze trackers**.

Adopted technology

- Optoelectronics (video-camera based)
 - Marker based
 - Computer vision
 - Scanner based.
- Magnetical
- Acoustical
- Mechanical
- Inertial



What is motion capture?



Ensemble of techniques and methodologies to acquire **automatically** the motion of the objects of interest.

Characteristics: sampling rate, accuracy, 2D/3D, real-time, motion amplitude, invasivity,....

Technology: opto-electronical, magnetical, ultrasound, inertial

Specific body parts: gloves, gaze trackers....

Applications are increasing (medical applications at the origin, now interest in the entertainment, robotics, reverse engineering ...)



Motion Capture and Synthesis



Reproduce digitally the motion of the body (in real-time in case of tracker).

Time series of the position of the body segments
or
Time series of the motion of the articulations.

Analysis
Info extraction

Application of the time series to a
3D digital model of the body.

Synthesis
Avatar animation



Uncanny Valley

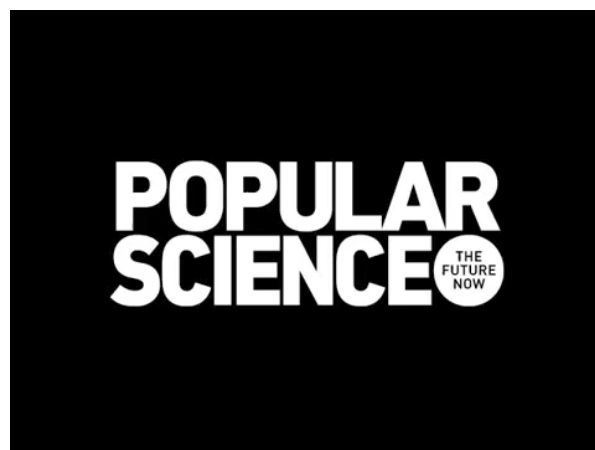



Avatar designed avoiding the "uncanny" valley

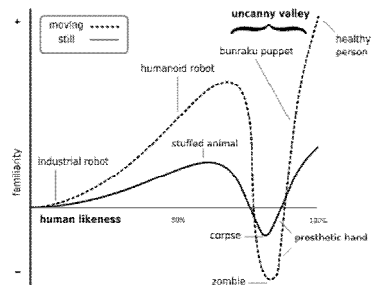

Mori, Masahiro (1970). Bukimi no tani The uncanny valley (K. F. MacDorman & T. Minato, Trans.). Energy, 7(4), 33-35. (Originally in Japanese)

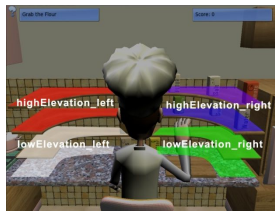

A.A. 2016-2017

15/80

<http://borghese.di.unimi.it/>



What is captured?



Silhouette (-> Skeleton)

Skeleton

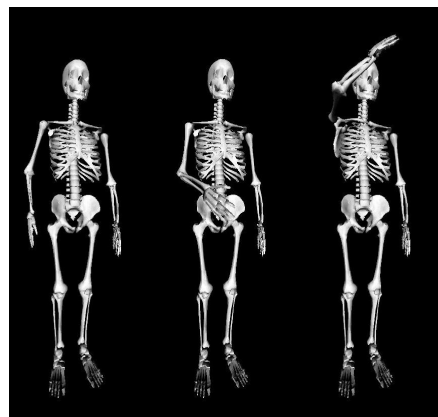
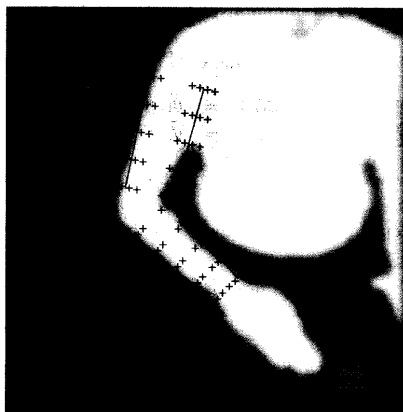

Computer vision techniques (silhouette)

Bony segments or articulations (marker-based systems / Kinect)

A.A. 2016-2017

16/80

<http://borghese.di.unimi.it/>



Description of the human skeleton

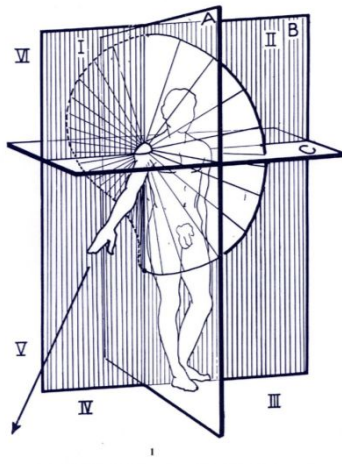

A – Frontal plane
B – Sagittal plane
C – Horizontal plane

Abduction/adduction
Flexion/extension
Axial rotation (V)
Quaternions for 3D rotations

3D position of joint extremes

Definition of the interesting degrees of freedom.

A.A. 2016-2017

17/80

<http://borghese.di.unimi.it/>



Why passive markers?



Minimum encumbrance on the subject: markers do not require any powering and are hardly sensed by the subjects.

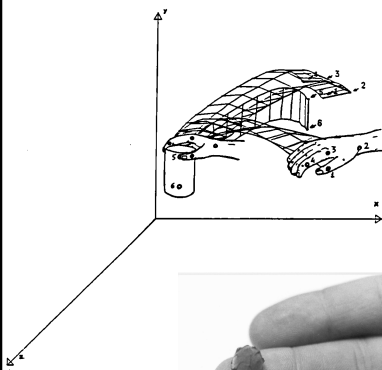

No constraint on the dimension of the working volume is prescribed.

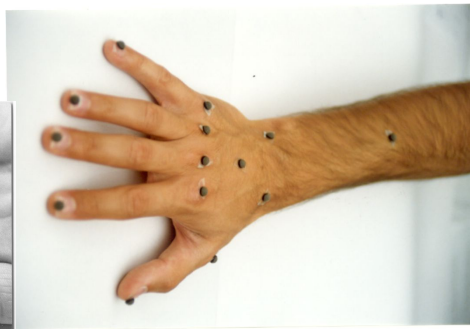
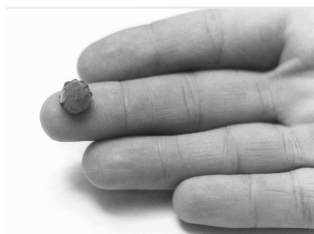

A.A. 2016-2017

<http://borghese.di.unimi.it/>



How passive markers work?



Passive markers are constituted of a small plastic support covered with retro-reflecting material (3M™). It marks a certain repera point.

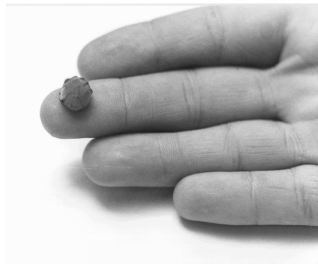

Video-cameras are equipped with a co-axial flash.

Markers appear much brighter than the background making their detection, on the video images, easier.

A.A. 2016-2017

19/80

<http://borghese.di.unimi.it/>



Motion Capture through markers



<http://www.vicon.com/applications/games.html>

Vicon system from Oxford Metrix

A.A. 2016-2017

20/80

<http://borghese.di.unimi.it/>



Tracking difficulties



It is a complex problem because:

- Dense set of markers. These may come very close one to the other in certain instants.

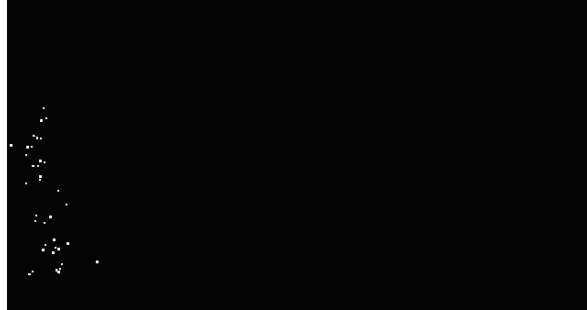

- Motion can be easily complex, as it involves rotation and twists of the different body parts (thing at a gymnastic movement).
- Multi-camera information and temporal information is required to achieve a robust tracking.



Tracking difficulties



It is a complex problem because:

- Dense set of markers. These may come very close one to the other in certain instants.

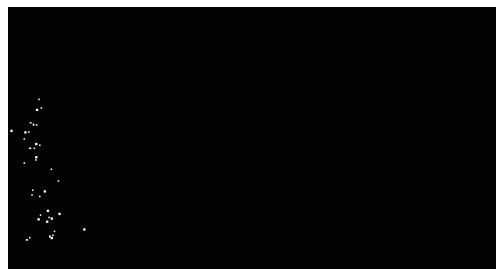

- Motion can be easily complex, as it involves rotation and twists of the different body parts (thing at a gymnastic movement).
- Multi-camera information and temporal information is required to achieve a robust tracking.



Sequential processing



1. Surveying the image of the moving subject on multiple cameras (*frequency & set-up*).
2. Markers extraction from the background scene (*accuracy & reliability*).
3. Computation of the “real” 2D position of the markers (*accuracy <- distortion*).

Low-level
Vision

4. **Matching on multiple cameras.**
5. 3D Reconstruction (*accuracy*).

High-level
Vision

6. **Model fitting (*labelling, classification*).**

Semantic

An implicit step is CALIBRATION.

A.A. 2016-2017

23/80

<http://borghese.di.unimi.it/>



Disadvantages of motion capture systems based on passive markers



When a marker is hidden to the cameras by another body part (e.g. the arm which swings over the hip during gait), the motion capture loses track of it.

The multiple set of 2D data have to be correctly labeled and associated to their corresponding 3D markers.

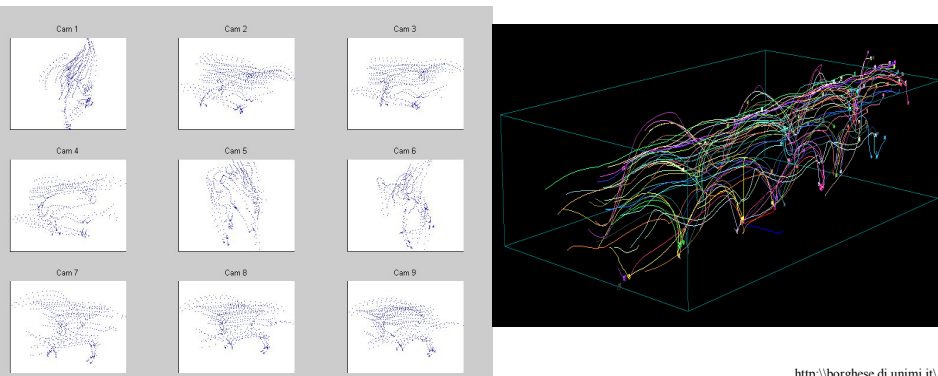

<http://borghese.di.unimi.it/>



Tracking difficulties



It is a complex problem because:

- Dense set of markers. These may come very close one to the other in certain instants.

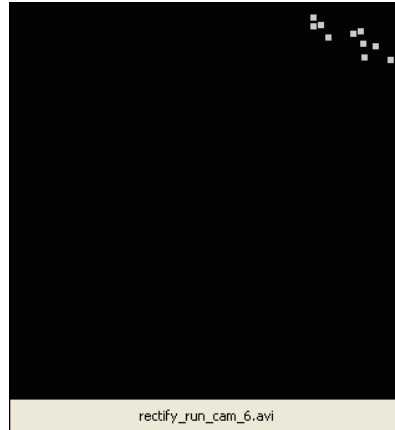

- Motion can be easily complex, as it involves rotation and twists of the different body parts (thing at a gymnastic movement).
- Multi-camera information and temporal information is required to achieve a robust tracking.



2D tracking

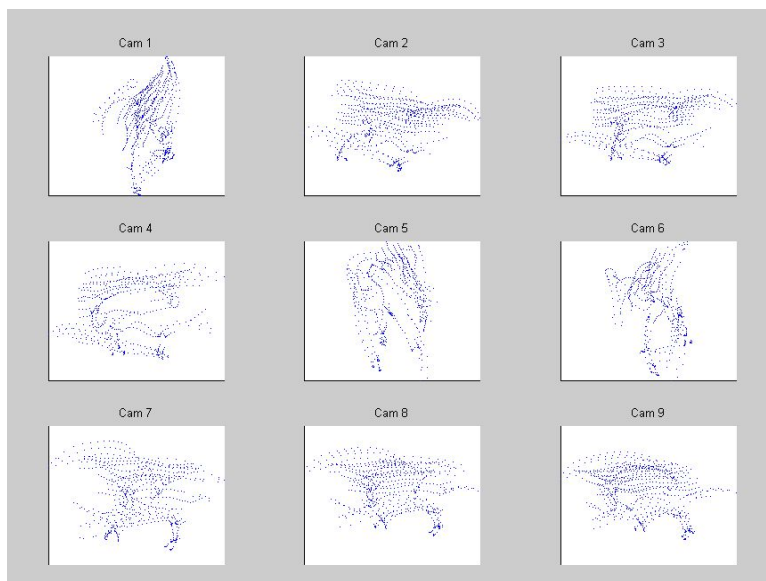



1) Creation of 2D strings

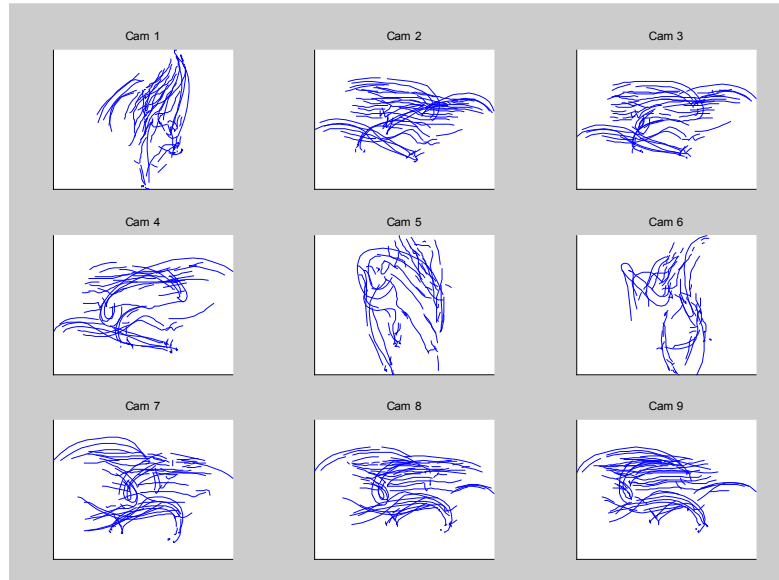

A.A. 2016-2017

27/80

<http://borghese.di.unimi.it/>



2) Matching 2D strings



Epipolarity constraint

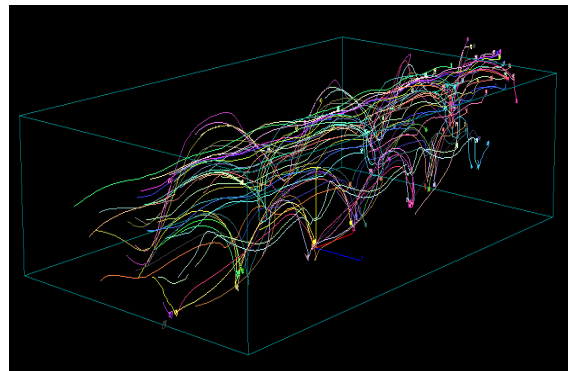
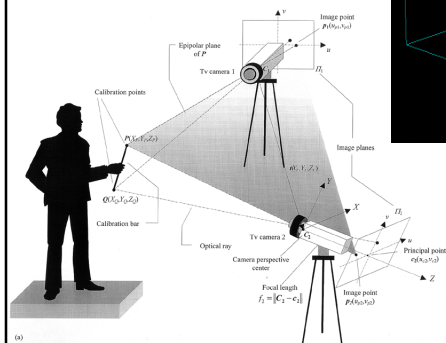

3D strings

A.A. 2016-2017

28/80

<http://borghese.di.unimi.it/>



3) Condensation of 3D strings

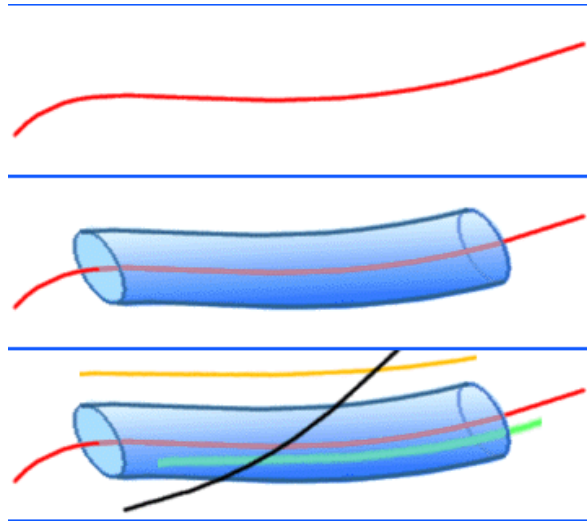

A.A. 2016-2017

29/80

<http://borghese.di.unimi.it/>



4) Joining 3D strings

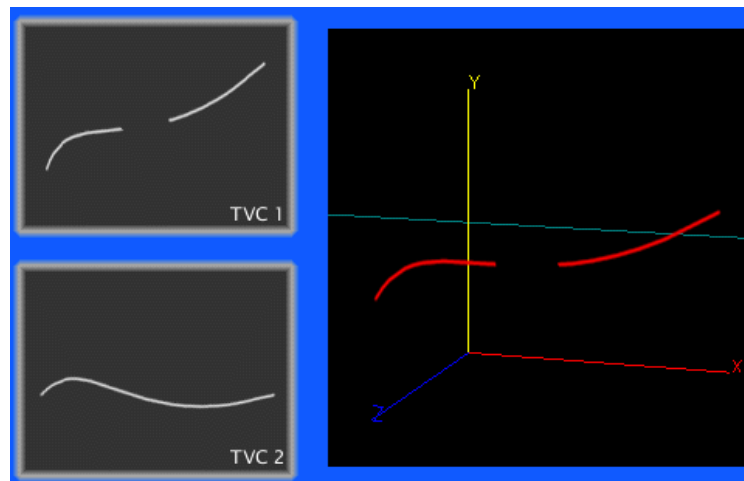

A.A. 2016-2017

30/80

<http://borghese.di.unimi.it/>



3D strings



3D strings already contain motion 3D information



3D strings

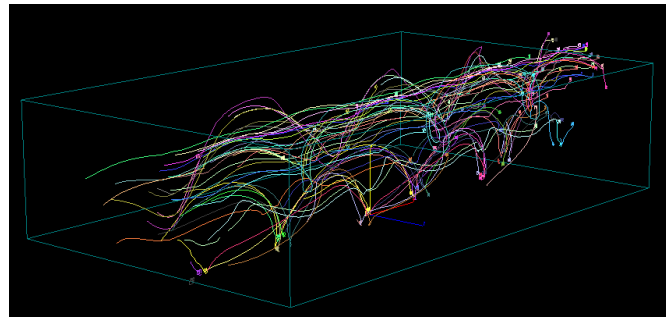
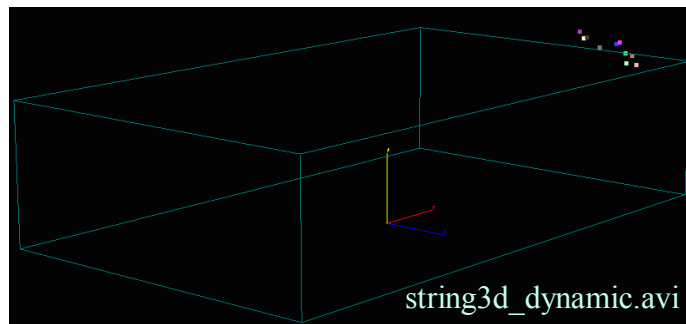

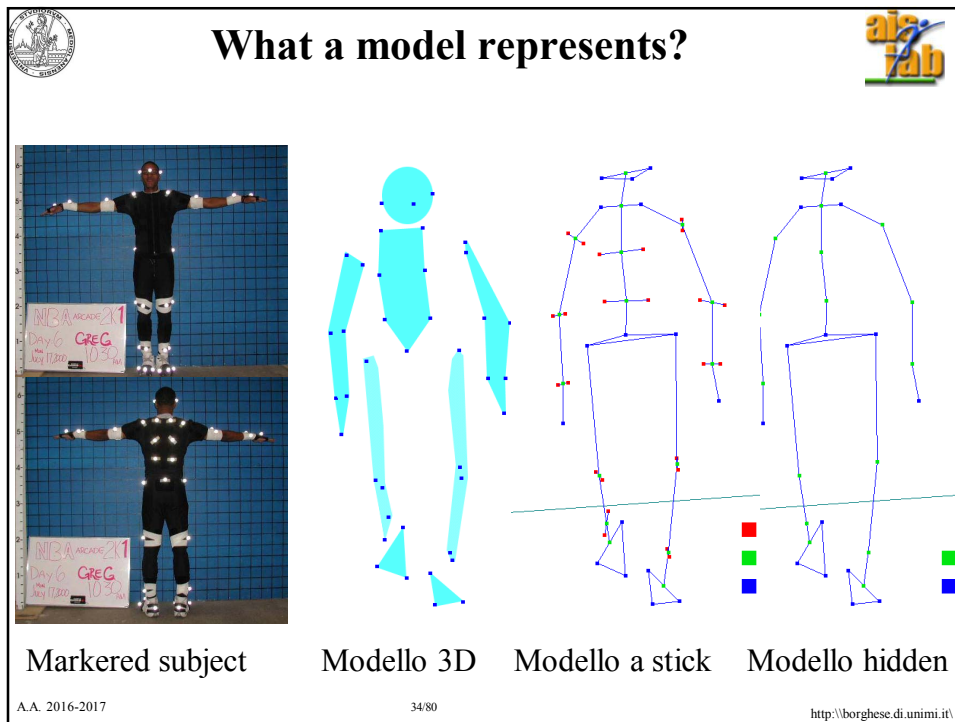
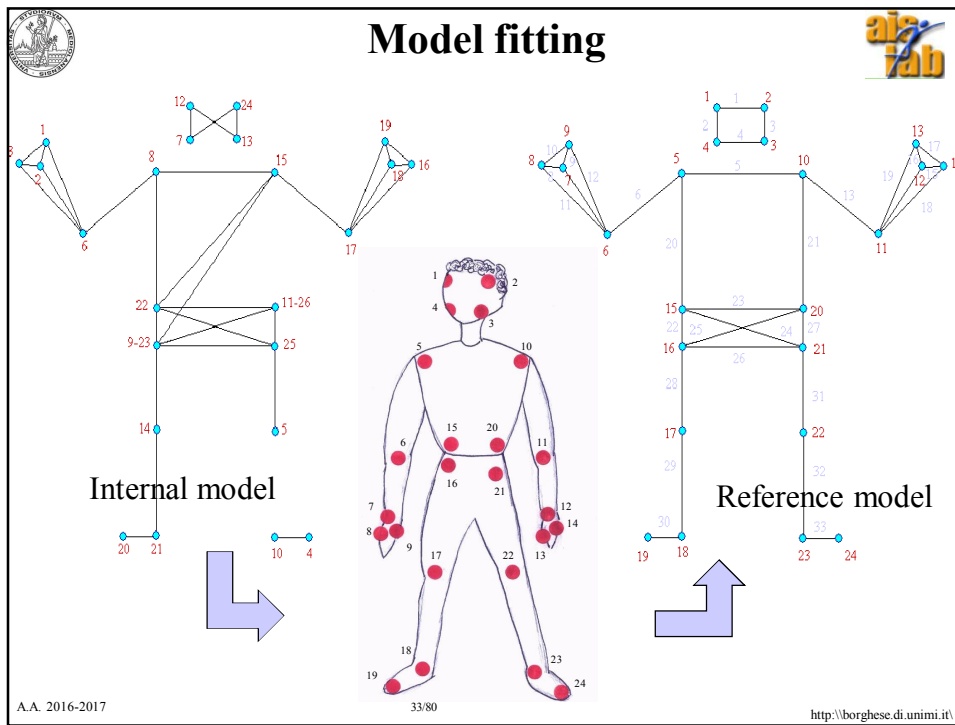



Problems intrinsic in body tracking



- Joints are points inside the body, markers are attached on the body surface.
- Joint are not fixed points: two adjacent bones rotate and slide.
- Joint are not spherical.
- Joints can be complex (e.g. Shoulder, spine)
- Skin artifacts.



The human skeleton has complex articulations



“Rigid” bones connected. Tendons keep the bones in place.

Motion allowed can be very complex (e.g. shoulder, spine).

The reconstruction of the finest details of the motion are beyond reach, simplifying assumptions are made => ***Level of detail*** in motion analysis

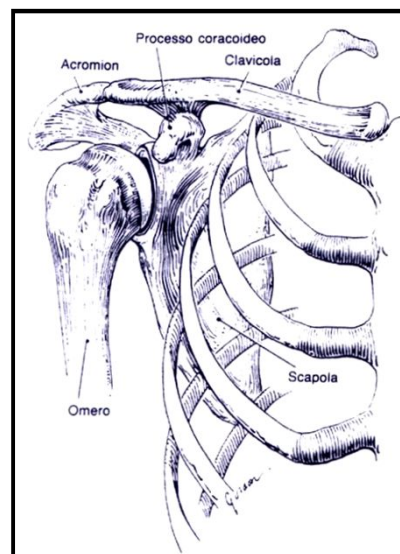



Video by Superfluo

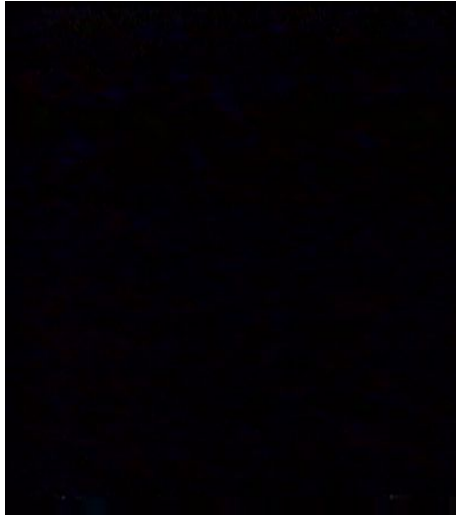

superfluo3.wmv

A.A. 2016-2017

37/80

<http://borghese.di.unimi.it/>



Risultati: escape

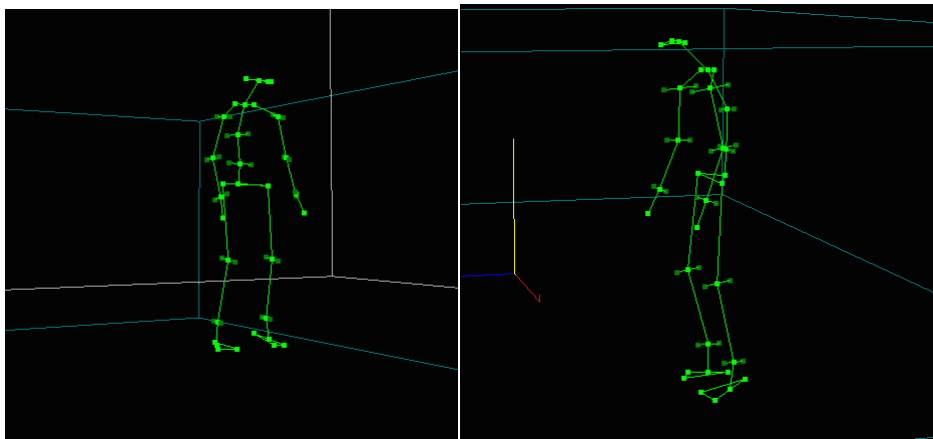

A.A. 2016-2017

38/80

<http://borghese.di.unimi.it/>



Risultati: fall_run

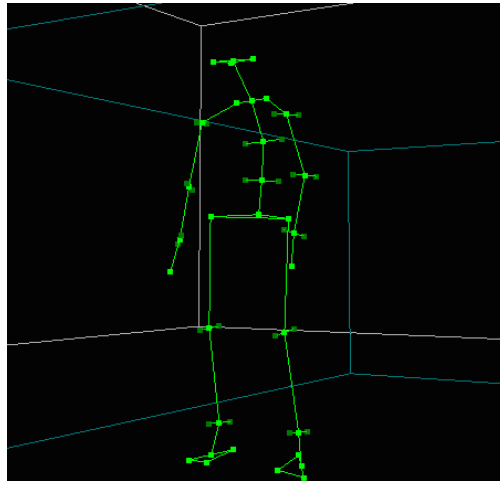

A.A. 2016-2017

39/80

<http://borghese.di.unimi.it/>



Risultati: roll

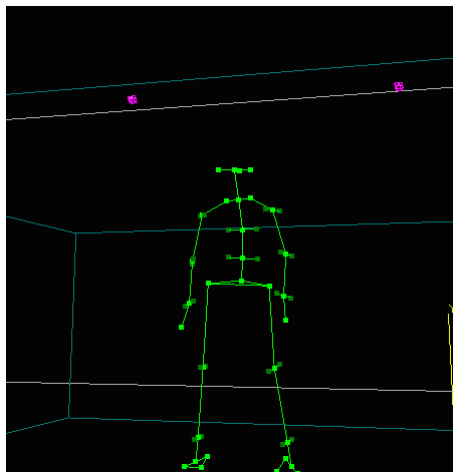

A.A. 2016-2017

40/80

<http://borghese.di.unimi.it/>



High jump – top athletes

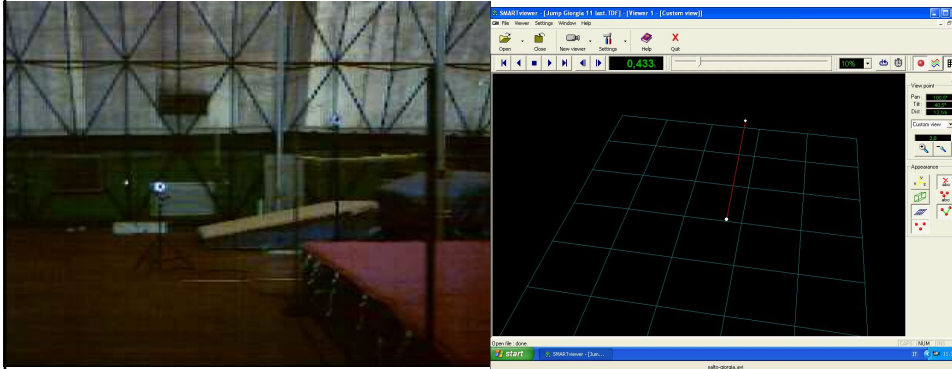

A.A. 2016-2017

41/80

<http://borghese.di.unimi.it/>



Can we work without markers?



Edward Muybridge 1878-1901

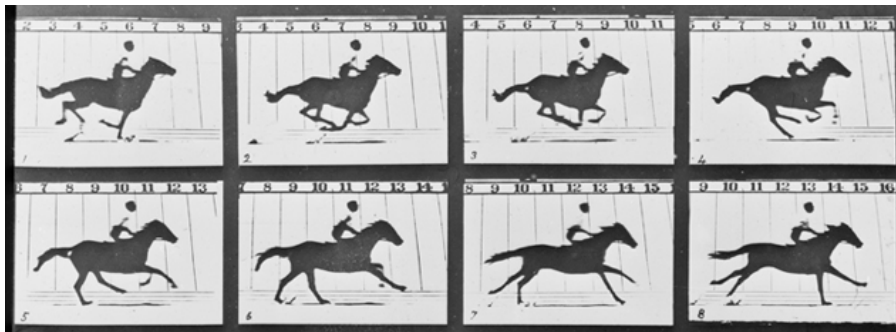

<http://www.edwardmuybridge.co.uk/>

A.A. 2016-2017

42/80

<http://borghese.di.unimi.it/>



Edward Muybridge 1878-1901

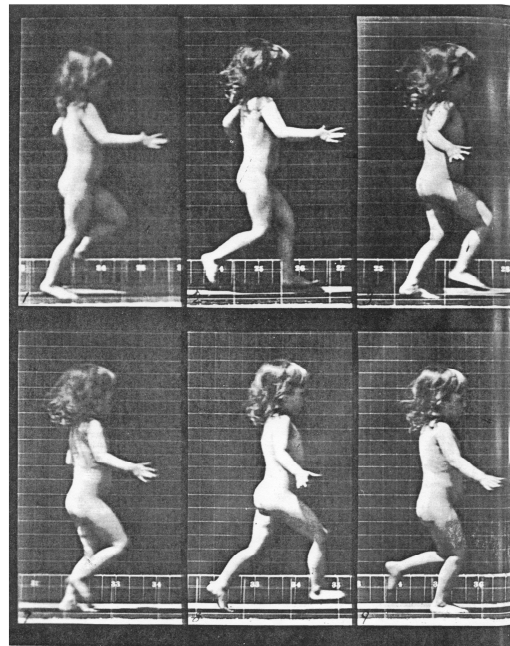

A.A. 2016-2017

43/80

<http://borghese.di.unimi.it/>



Computer vision techniques



Silhouette (-> Skeleton)

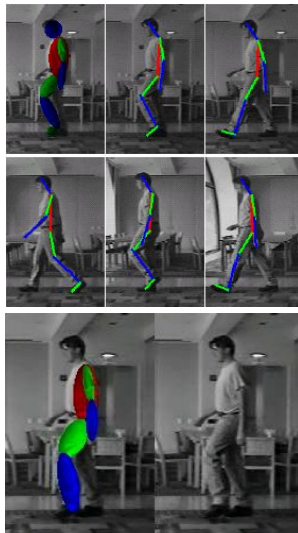

Set of difficult problems:

2D Image processing (silhouette identification, optical flow detectors...)

Multi-view invariants.

Smooth motion -> temporal filtering.

Skeleton fitting (different rigid motion for different segments).

3D cameras help a lot

<http://movement.stanford.edu/>

A.A. 2016-2017

44/80

<http://borghese.di.unimi.it/>



Results: stepping (640 x 480, 10Hz)



Mikic, Trivedi, Hunter

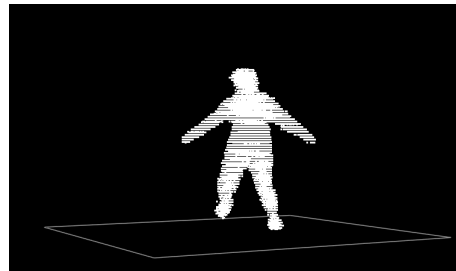
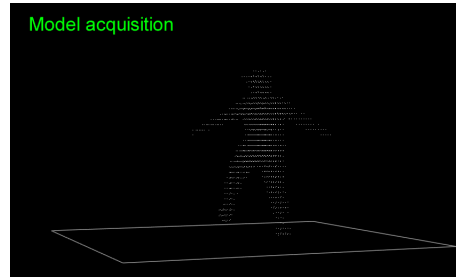

A.A. 2016-2017

45/80

<http://borghese.di.unimi.it/>



Results: cartwheel

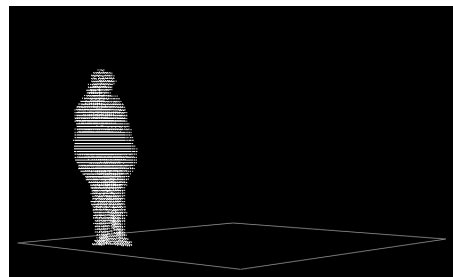
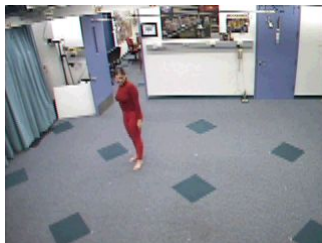

A.A. 2016-2017

46/80

<http://borghese.di.unimi.it/>



Body motion from footage (Structure from Motion)

2 approcci:

- Probabilistico. Stima di un modello parametrizzato e dei parametri di movimento.
- Deterministico. Definisco un modello a-priori e stimo i parametri della camera e del movimento.



A.A. 2016-2017

47/80

<http://borghese.di.unimi.it/>



2D color coded tracking

- Players could interact with a 3D scene by moving known brightly saturated colored objects that were visually tracked in PlayStation 2 (EyeToy Webcam). Threshold on color representation.
- Pose recovery can be accomplished robustly for certain shapes of known physical dimensions by measuring the statistical properties of the shape's 2D projection. In this manner, for a sphere the 3D position can be recovered (but no orientation), and for a cylinder, the 3D position and a portion of the orientation can be recovered.



- Multiple objects can be also be combined for complete 3D pose recovery, though occlusion issues arise.
- Perfect recognition in all lighting conditions is difficult.

A.A. 2016-2017

48/80

<http://borghese.di.unimi.it/>



2D collision detection

- Collision detection with target can be checked by analyzing the overlapping between part of the motion mask only in particular regions.
- Identification of the motion mask as the outermost part of the body. Approximated collision detection defining general shapes.

Correct Hand collision area
(most left pixel in the area around first top most high pixel)

- Collision with targets gives hit, collision with distractors gives a miss.
- Same principles implemented with Sony EyeToy Webcam (2003).

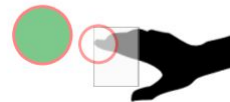

A.A. 2016-2017

49/80

:di.unimi.it\



Markerless optical motion capture

- Clustering and labeling of each image with a probabilistic framework.
- Addition of temporal and spatial constraints.
- Special stage place is required.
- Cost and complexity

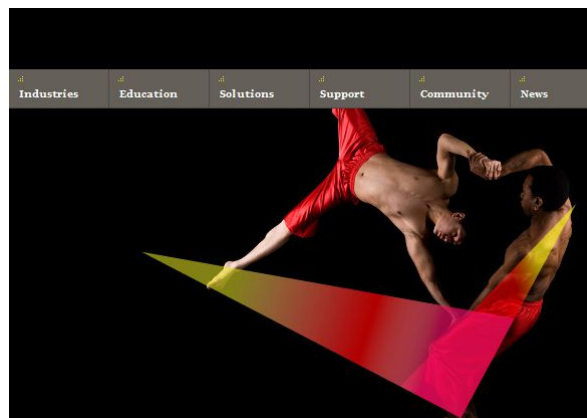

www.organicmotion.com

A.A. 2016-2017

50/80

<http://borghese.di.unimi.it/>



2D tracking for rehabilitation



Duck-neglect project <http://borgnese.dsi.unimi.it/Research/LinesResearch/Virtual/Virtual.html>

"Magic mirror" paradigm in which video of the player is overlaid with graphics generated by the computer.



Background measurement. Thresholding.

In this case, silhouette is tracked.

Alternative is the difference between consecutive images (glaring and blurring require some filtering).

[duckNeglect_video_v0.mov](#)

A.A. 2016-2017

51/80

<http://borgnese.dsi.unimi.it/>



La camera come strumento di ripresa



Come si forma un'immagine?

- Scena con oggetti riflettenti.
- Sorgente di illuminazione
- Piano di rilevazione della luce riflessa.



Il motore di questa trasformazione è la **proiezione prospettica**.

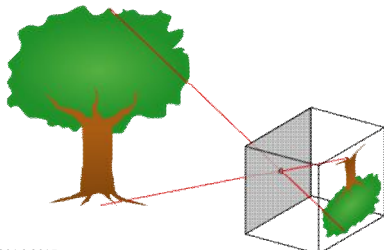

Modello pin-hole

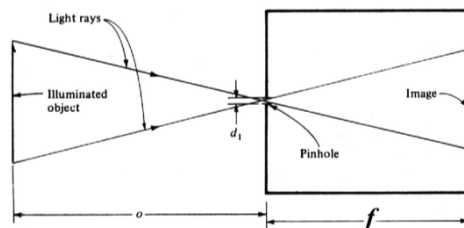

A.A. 2016-2017

52/80

<http://borgnese.dsi.unimi.it/>



La pin-hole camera

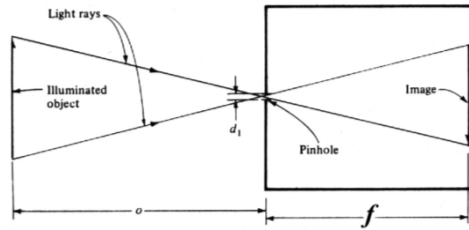

Proiezione prospettica:
tutti i raggi di proiezione
passano per un unico punto,
detto **centro di proiezione**.

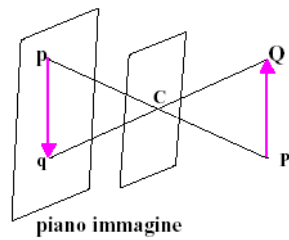

Pinhole camera

A.A. 2016-2017

53/80

<http://borghese.di.unimi.it/>



La lente

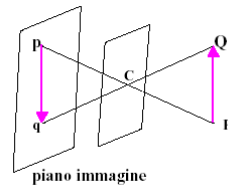

Pinhole camera

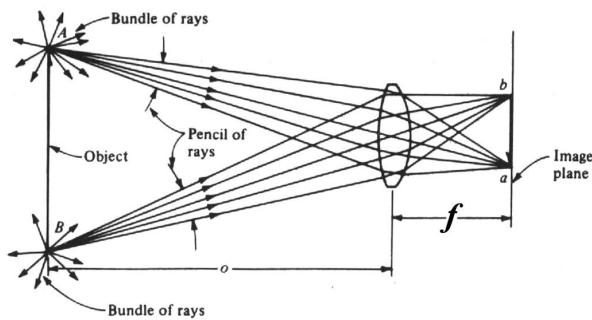

Lente convergente

A.A. 2016-2017

54/80

<http://borghese.di.unimi.it/>



Geometria dell'ottica

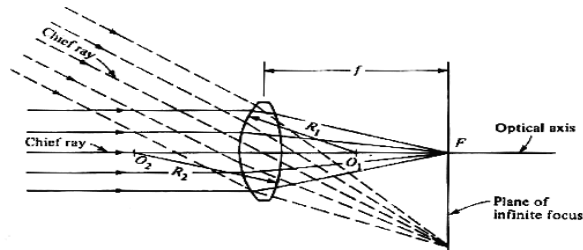

Oggetti all'infinito

- **Distanza focale**: distanza del piano immagine quando un oggetto si trova all'infinito.
- **Asse ottico**: raggio che non viene deviato dalla lente.
- Intersezione dell'asse ottico con il piano immagine dà il **punto principale (F)**.

A.A. 2016-2017

55/80

<http://borghese.di.unimi.it/>



Messa a fuoco



Problema della messa a fuoco

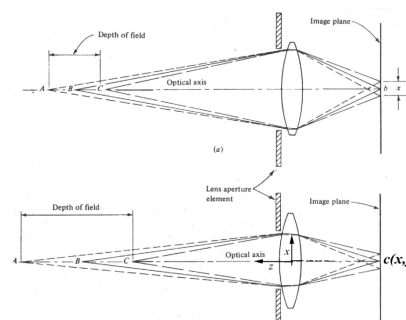

Parametri di camera (o intrinseci):

- **Punto principale $c(x,y)$** + lunghezza focale, f (3 parametri).
- Occorre conoscere anche il fattore di forma dei pixel nel caso di immagini digitali (è una costante, non un parametro).
- (Distorsioni).

A.A. 2016-2017

56/80

<http://borghese.di.unimi.it/>



L'occhio umano

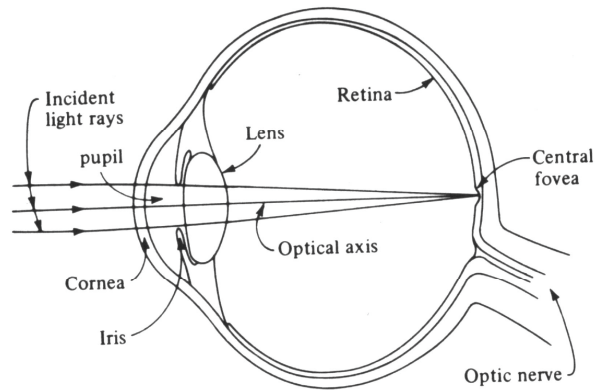

Its behavior is very similar to that of a camera

A.A. 2016-2017

57/80

<http://borghese.di.unimi.it/>



2.5D cameras (Kinect)



- 3D scanner with active pattern (IR)
- RGB camera
- Robust background separation
- Robust skeletal tracking

Used as a Web-cam with advanced silhouette subtraction for rehabilitation.

Come to our lab and see...

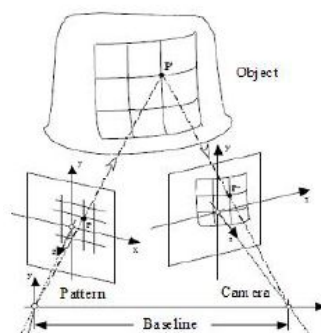

A.A. 2016-2017

58/80

<http://borghese.di.unimi.it/>



2.5D First SDK for Kinect

Primesense drivers, with skeleton tracking: <http://www.primesense.com/se.com>

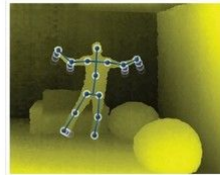

Color (RGB) Image



Depth Image



Audio Stream

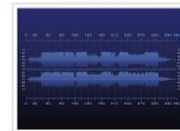

Open Source drivers:

<http://openni.org>

http://openkinect.org/wiki/Main_Page

Microsoft's SDK is available

A.A. 2016-2017

59/80

<http://borghese.di.unimi.it/>



Calibration is a pre-requisite

Camera calibration

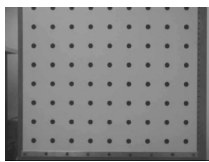
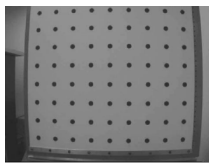

Set-up calibration

Excellent for special effects, not so good for measurements....
Cameras are not metric.

A.A. 2016-2017

60/80

<http://borghese.di.unimi.it/>



Inertial tracking::Wii

$$pitch = \arctan\left(\frac{a_z}{a_y}\right)$$
$$roll = \arctan\left(\frac{a_z}{a_x}\right)$$

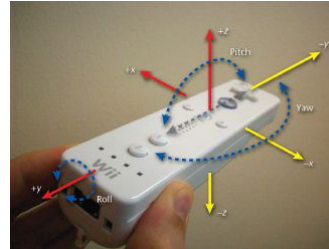

Positional data are obtained through integration.

⇒ Instability. A flip of the LSB for one frame generates a rotation at constant speed!!

Other devices are required to stabilize the measurements: Nunchuk (gyroscope), sensor IR-bar



Inertial tracking::Xsens

- Xsens by Moven is a full-body, camera-less inertial motion capture (MoCap) solution. It is flexible motion capture system that can be used indoors or outdoors (on-set). With the short turnaround times MVN is a cost effective system with clean and smooth data.

- Costly

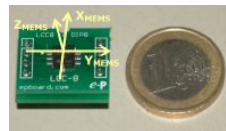

- We have used such system inside the FITREHAB project:

<http://www.innovation4welfare.eu/287/subprojects/fitrehab.html>



Where are we now (optoelectronic)?



Optotrak, 1991.

LED + cameras



- Measure the position of the joints.
- Time multiplexing for the markers (3 at 450Hz or 750Hz with additional hardware). No-tracking, real-time.
- Power for the LEDs has to be delivered on the subject's body (markers get hot on the skin!!).
- Accuracy 0.1mm (X,Y), 0.15mm (Z, depth).

A.A. 2016-2017

63/80

<http://borghese.di.unimi.it/>



Where are we now (magnetic)?



Magnetic technology: Fastrack & older Polhemus sensors.

They measure: pitch, yaw and roll; X, Y, Z of the segments.

Electro-magnetic induction.



The transmitter is a triad of electromagnetic coils, enclosed in a plastic shell, that emits the magnetic fields. The transmitter is the system's reference frame for receiver measurements.

The receiver is a small triad of electromagnetic coils, enclosed in a plastic shell, that detects the magnetic fields emitted by the transmitter. The receiver is a lightweight cube whose position and orientation are precisely measured as it is moved.

A.A. 2016-2017

64/80

<http://borghese.di.unimi.it/>



Fast-track Motion Capture



- Higher accuracy through oversampling and DSP signal processing (0,5" and 1.8mm accuracy). Range of 75cm for high accuracy.
- Sensitive to ferromagnetic (metallic) objects.

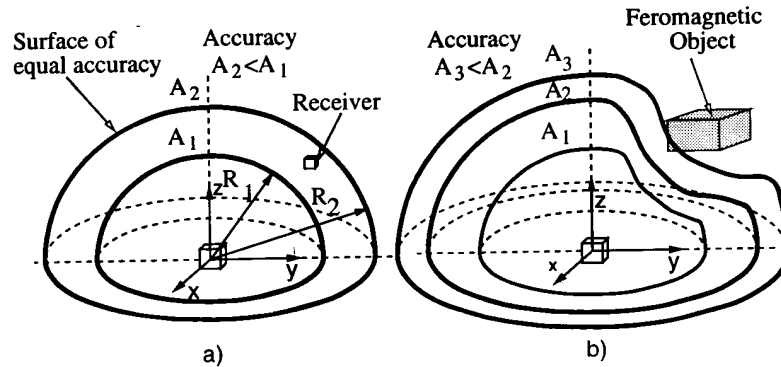

- Latency: 4msec.
- Sampling rate: 120Hz. Rate drop with multiple receivers because of multiplexing.

A.A. 2016-2017

65/80

<http://borghese.di.unimi.it/>



Flock of birds Motion Capture

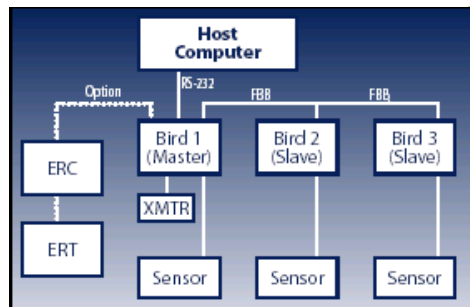

- Each receiver has its own DSP.
- All the DSP are connected with a fast internal bus.
- Latency is increased (8ms).

When more than one transmitter is adopted (experimental):
 larger field (single transmitter at a time)
 higher accuracy (time-slicing)

Not really un-obtrusive! Low accuracy. Real-time.

A.A. 2016-2017

66/80

<http://borghese.di.unimi.it/>



Gloves



Monitor fingers position and force.

Problems with the motion of the fingers:

- overlap.
- fine movements.
- fast movements.
- rich repertoire.



Sayre glove (1976)

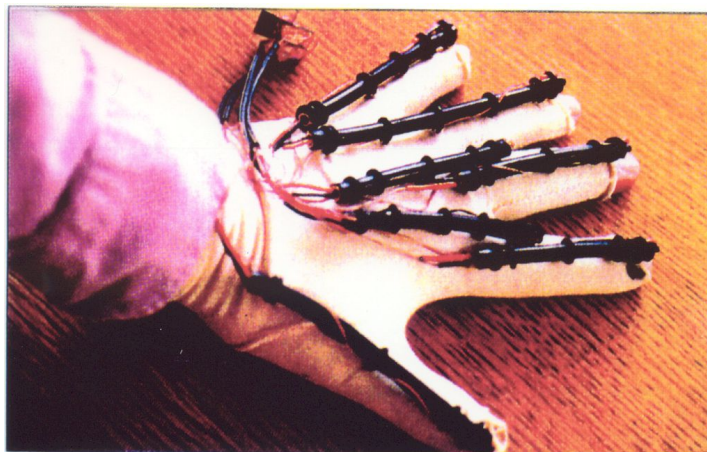



MIT glove (1977)



A.A. 2016-2017

69/80

<http://borghese.di.unimi.it/>



Digital Data Entry Glove (1983)

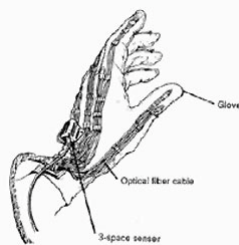

© AT&T Bell Labs

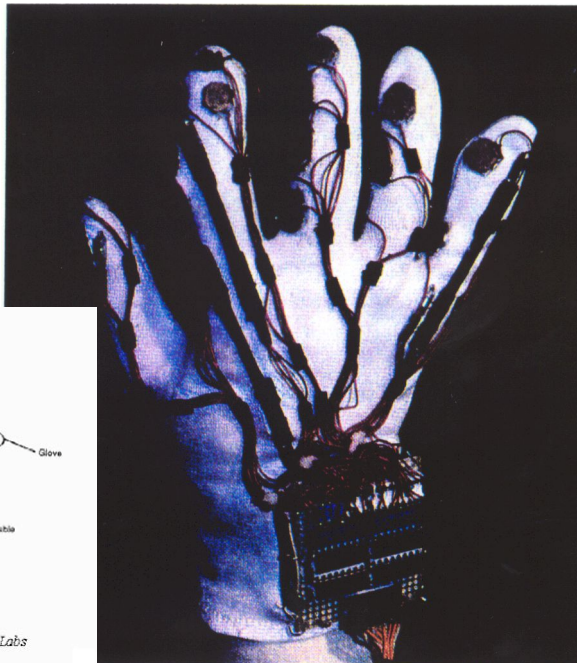

A.A. 2016-2017

70/80

<http://borghese.di.unimi.it/>



Data Glove (1987)

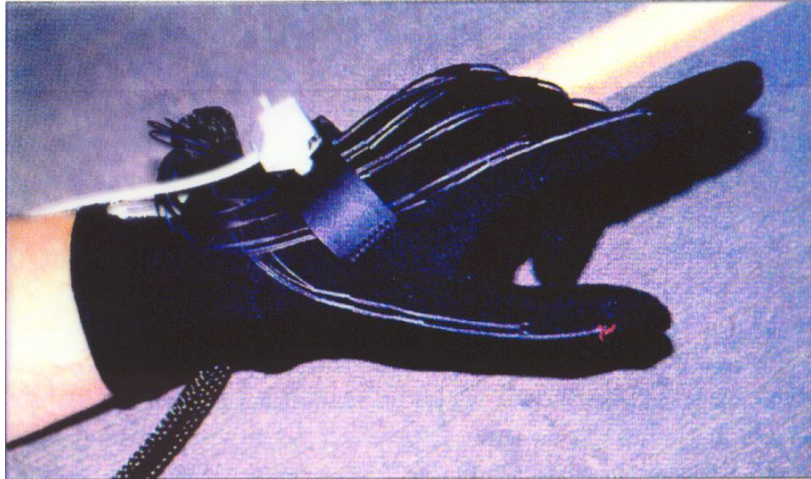

A.A. 2016-2017

71/80

<http://borghese.di.unimi.it/>



Power Glove (1990)



A.A. 2016-2017

72/80

<http://borghese.di.unimi.it/>



Cyber Glove (1995)



A.A. 2016-2017

73/80

<http://borghese.di.unimi.it/>



AcceleGlove / iGlove (2009)



http://www.anthrotronix.com/index.php?option=com_content&view=article&id=87&Itemid=138

A.A. 2016-2017

74/80

<http://borghese.di.unimi.it/>



Calibration



Estimate of the geometrical parameters in the transformation operated by the sensors (e.g. the perspective transformation operated by a video-camera).

Estimate of the parameters, which describe distortions introduced by the measurement system.

Measurement of a known pattern. From its distortion, the parameters can be computed.

Algorithms adopted: polynomial, local correction (neural networks, fuzzy).



Finger tracking through cameras



The screenshot shows the HP Leap Motion website. At the top, the navigation menu includes: LEAP M O T I O N, PRODUCT, VR, APPS, DEVELOPER, SOLUTIONS, COMMUNITY, SETUP, and BUY. The main content area features a video player showing a person's hands interacting with a laptop. A green circle highlights the Leap Motion sensor on the desk. Below the video, there is a section for the HP Leap Motion Keyboard with the following text: "HP Leap Motion Keyboard. The HP Leap Motion Keyboard is the first-ever keyboard with integrated Leap Motion technology. Plug into a compatible HP device and transform the way you experience your digital world."



Gaze input



- Contact lenses carrying magnetic coils.
- TV cameras aligned with an IR LED source.
- Stereoscopic eye-wear.
- The direction of gaze is decided by measuring the shape of the spot reflected by the frontal portion of the cornea (Ohshima et al., 1996).
- Eye trax <http://www.eyetrax.it/en/index.html>

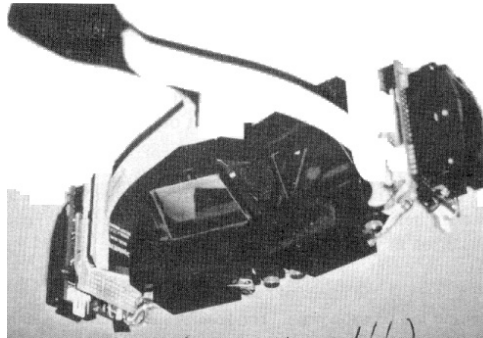

A.A. 2016-2017

77/80

<http://borghese.di.unimi.it/>



Vision based eye trackers

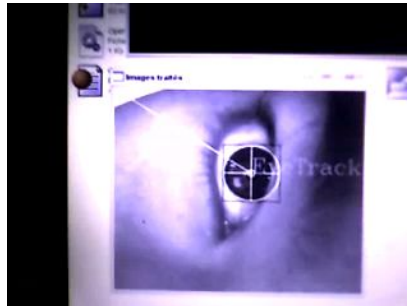

Logitech Quickcam 4000

- Color information
- Geometry information (circles, relative position...)
- Histogram analysis on gray level.
- Custom tool for many WEBCams
- ...



EyeTribe - <https://theyetribe.com/>. Passive. 99 US \$

A.A. 2016-2017

78/80

<http://borghese.di.unimi.it/>



History



Video technology (semi-automatic marker detection, slow-motion, 1975)

Optoelectronic active markers: Selspot™ 1977 (Selspot II 1993), Watsmart™ 1985, Optotrack™ 1992, Polaris™ 1998. <http://www.ndigital.com/home.html>

Automatic video marker detection:

Vicon™ 1981. <http://www.oxfordmetrics.com/>

Elite™ 1988. <http://www.bts.it/>

MotionAnalysis™ 1992, Eagle™ 2001. <http://www.motionanalysis.com/>

Smart™ 2000. <http://www.motion-engineering.com/>

Magnetic systems:

Sensors: Polhemus 1987, Fastrack 1993. <http://www.polhemus.com/>

Systems: Flock of birds 1994. <http://www.ascension-tech.com/>

Intertial systems: Xmoven Xsense 2000, Wii 2008.

Video processing: organicmotion 2010.

3D video systems: Kinect 2010, <http://www.microsoft.com/en-us/kinectforwindows/>



Sommario



- Introduzione
- Sistemi di Input
- Generatori di mondi
- Motore di calcolo
- Sistemi di Output
- Conclusioni